

LUA loudspeakers are specially indicated for fixed installations and those applications in which acoustical performance and aesthetics are essential, above absolute power delivery and road-readiness.

LUA5i has been designed as a High-Fidelity Work-horse for installations of distributed audio that require truly superior BGM reproduction with minimal impact on the aesthetics of the location and truly rugged and solid construction compared to most products in this category.

LUA5i features a 1" dome tweeter and a high-performance 5" woofer in a front-firing ported trapezoidal cabinet built with 12-mm Birch plywood and durable, high resistant IDEA paint coating. The front side of the loudspeaker is protected by a 1.5-mm weatherized steel grille and a internal protective foam.

Installation of **LUA5i** is a quick, straightforward operation thanks to the included rear wall-mount accessory. Six M6 inserts in the rear side of the cabinet allow for both vertical and horizontal installation with the wall-mount bracket.

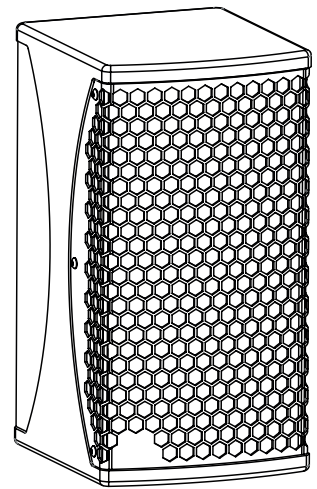

INSTALLATION ACCESSORY

LUA5i has an installation accessory for both vertical and horizontal positioning and different angulation points for precised and controlled coverage.

Fit the U-Bracket to the wall, then choose among the threaded M8 inserts in the rear panel to position the loudspeaker vertically or horizontally and set the desired angulation.

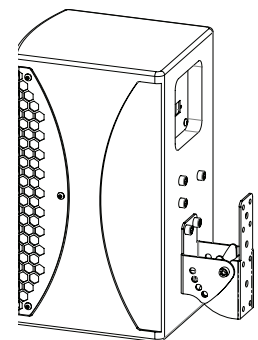
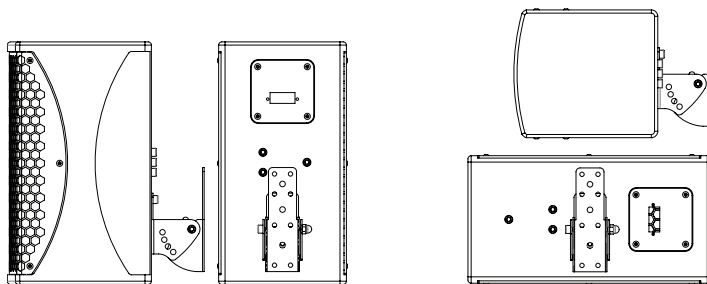
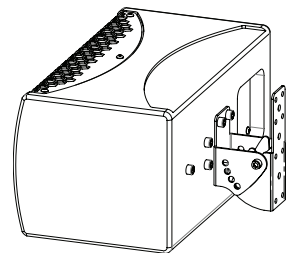

SYSTEM CONFIGURATION AND SETTINGS

LUA5i is a high performance loudspeaker that requires the LF reinforcement of BASSO Series subwoofers **BASSO10**, wall-mount **BASSO10i** and super-shallow **BASSO12t** (other third-party loudspeakers can also be used provided the settings of the system are preserved).

**Butt 24
60 Hz**

For best results and long-life performance of this professional audio equipment, a High-Pass Filter Butterworth 24 dB at 60 Hz must be set.



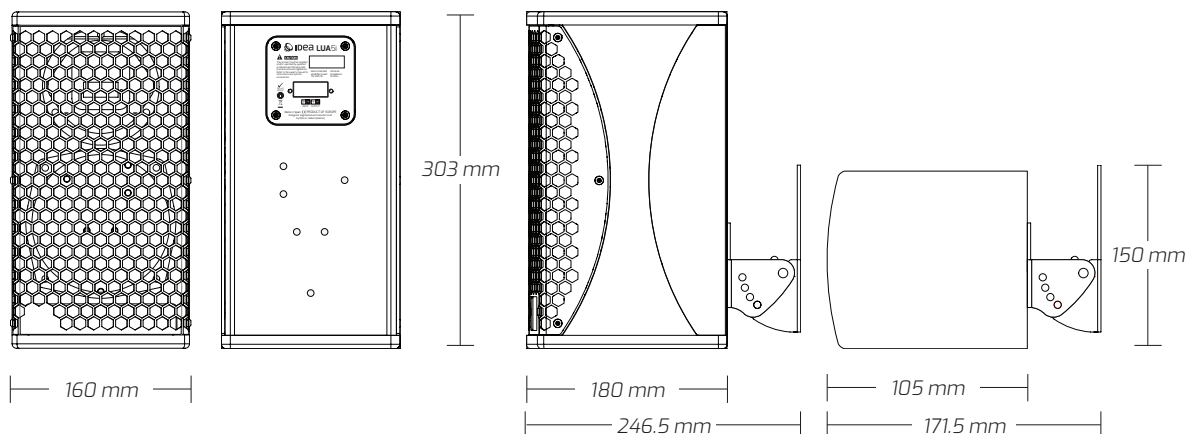

TECHNICAL DATA

Enclosure design	Rectangular
HF Transducer	1" Dome Tweeter
LF Transducer	1 x 5" High performance woofer
Power Handling (RMS)	150 W
Nominal Impedance	16 Ohm (8Ω version available on demand)
SPL (Continuous/Peak)	113/119 dB SPL
Frequency Range (-10 dB)	87 - 23000 Hz
Frequency Range (-3 dB)	120 - 180000 Hz
Coverage	70° Axisymmetric
Dimensions (WxHxD)	160 x 303 x 180 mm (6.3 x 11.9 x 7.1 in)
Weight	5.6 kg (12.3lb)
Connectors	Euroblock
Cabinet Construction	15 mm Birch Plywood
Grille	1.5 mm perforated weatherised steel with protective foam
Finish	Durable IDEA proprietary Aquaforce high-resistance paint coating process
Installation	6 x M6 inserts
Accessories	Wall mount (WM LUA5i)

TECHNICAL DRAWINGS



WARNINGS AND SAFETY GUIDELINES

- Read this document thoroughly, follow all safety warnings and keep it for future reference.
-  · The exclamation mark inside a triangle indicates that whatever repairing and component replacement operations must be done by qualified and authorized personnel.
- No user serviceable parts inside.
- Only use accessories tested and approved by IDEA and supplied by the manufacturer or an authorized dealer.
- Installations, rigging and suspension operations must be done by qualified personnel.
- Only use accessories specified by IDEA, complying with maximum loads specifications and following local safety regulations.
-  · Read the specifications and connection instructions before proceeding to connect the system and use only cabling supplied or recommended by IDEA. Connection of the system should be done by qualified personnel.
- Professional sound reinforcement systems can deliver high SPL levels that may result in hearing damage. Do not stand close to the system while in use.
-  · Loudspeaker produce magnetic field even while they are not in use or even when disconnected. Do not place or expose loudspeakers to any device that is sensitive to magnetic fields such as television monitors or data storage magnetic material.
- Disconnect the equipment during lightning storms and when it is not to be used for a long time.
- Do not expose this device to rain or moisture.
- Do not place any objects containing liquids, such as bottles or glasses, on the top of the unit. Do not splash liquids on the unit.
- Clean with a wet cloth. Do not use solvent-based cleaners.
- Regularly check the loudspeaker housings and accessories for visible signs of wear and tear, and replace them when necessary.
- Refer all servicing to qualified service personnel.
-  · This symbol on the product indicates that this product should not be treated as household waste. Follow local regulation for recycling of electronic devices.
- IDEA declines any responsibility from misuse that may result in malfunction or damage of the equipment.

WARRANTY

- All IDEA products are guaranteed against any manufacturing defect for a period of 5 years from date of purchase for acoustical parts and 2 years from date of purchase for electronic devices.
- The guarantee excludes damage from incorrect use of the product.
- Any guarantee repair, replacement and servicing must be exclusively done by the factory or any of authorized service centres.
- Do not open or intend to repair the product; otherwise servicing and replacement will not be applicable for guarantee repair.
- Return the damaged unit, at shipper's risk and freight prepaid, to the nearest service centre with a copy of the purchase invoice in order to claim guarantee service or replacement.

DECLARATION OF CONFORMITY

I MAS D ELECTROACÚSTICA SL
POL. A TRABE 19-20 15350 CEDEIRA (GALICIA - SPAIN)
DECLARES THAT: **LUA5I**
COMPLIES WITH THE FOLLOWING EU DIRECTIVES:
ROHS (2002/95/CE) RESTRICTION OF HAZARDOUS SUBSTANCES
LVD (2006/95/CE) LOW VOLTAGE DIRECTIVE
EMC (2004/108/CE) ELECTRO-MAGNETIC COMPATIBILITY
WEEE (2002/96/CE) WASTE OF ELECTRIC AND ELECTRONIC EQUIPMENT
EN 60065: 2002 AUDIO, VIDEO AND SIMILAR ELECTRONIC APPARATUS. SAFETY REQUIREMENTS.
EN 55103-1: 1996 ELECTROMAGNETIC COMPATIBILITY: EMISSION
EN 55103-2: 1996 ELECTROMAGNETIC COMPATIBILITY: IMMUNITY



www.ideaproaudio.com



For further information scan the QR Code
or refer to the following web address: www.ideaproaudio.com/product-detail/lu-a-5i

IDEA is always in pursuit of better performance, greater reliability and design features.
Technical specifications and minor finish details may vary without notice in order to improve our products.

©2022 - I MAS D Electroacústica SL

PoL A Trabe 19-20 15350 Cedeira (Galicia - Spain)